



HUGRO®

Qualität aus Waldkirch

Gehäuse 2023/2024

Enclosures



Serien- und Sondergehäuse

Serial enclosures and customized solutions

IGWS 2.2

HUGRO-Armaturen GmbH

„Als führender Anbieter von **kundenspezifischen Systemlösungen** bei Kabelverschraubungen, Gehäusen und Zubehör ist HUGRO durch **proaktive Kundenähe, hoher Serviceorientierung** und **marktführender Lösungskompetenz** ein wertvoller Partner für Industrie und Produktion und schafft so nachhaltig hohe Werte für seine Kunden, Mitarbeiter, Partner und Gesellschafter!“



- > **riesiges Lager für Sofortversand**
huge stock for immediate dispatch
- > **TOP-Artikel unserer Premium-Produktionspartner**
TOP articles from our premium production partners
- > **schneller Versand von Muster-Bestellungen**
fast shipping of sample orders
- > **Zertifiziert nach ISO 9001:2015**
Certified according to ISO 9001:2015
- > **persönliche Beratung für Sie sofort erreichbar**
personal advice immediately available for you
- > **über 1.000 Warenbewegungen täglich**
more than 1,000 daily movements of goods
- > **Vertrieb und Service in über 80 Ländern**
Sales and service in over 80 countries
- > **großes Sortiment mit über 18.000 Referenzen**
large assortment with over 18,000 references

Wir sind für Sie da

Bei HUGRO stehen die Menschen im Mittelpunkt – keine noch so perfekt formulierte E-Mail kann ein persönliches Gespräch ersetzen. Hier sehen Sie, mit wem Sie sprechen und wer bei HUGRO der richtige Ansprechpartner für Sie und Ihr Anliegen ist:



Thomas Stock
Geschäftsführung
Telefon: **+49 7681 4073-11**
Mobil: **+49 172 1316333**
thomas.stock@hugro.com



Ralf Kaszemek
Vertriebsleitung
Telefon: **+49 7681 4073-30**
Mobil: **+49 162 5162221**
ralf.kaszemek@hugro.com



Martin Hurst
Produktmanager Gehäuse
Telefon: **+49 7681 4073-16**
martin.hurst@hugro.com



Harald Flaig
Key Account
Telefon: **+49 7681 4073-37**
harald.flaig@hugro.com

Die Adressen unserer Vertriebspartner national und international finden Sie hier:
www.hugro.com/kontakt/vertrieb

HUGRO-Armaturen GmbH

Rudolf-Blessing-Straße 5
79183 Waldkirch / Germany

Tel. +49 (0) 76 81 / 40 73-0

Fax +49 (0) 76 81 / 40 73-40

E-Mail info@hugro.com

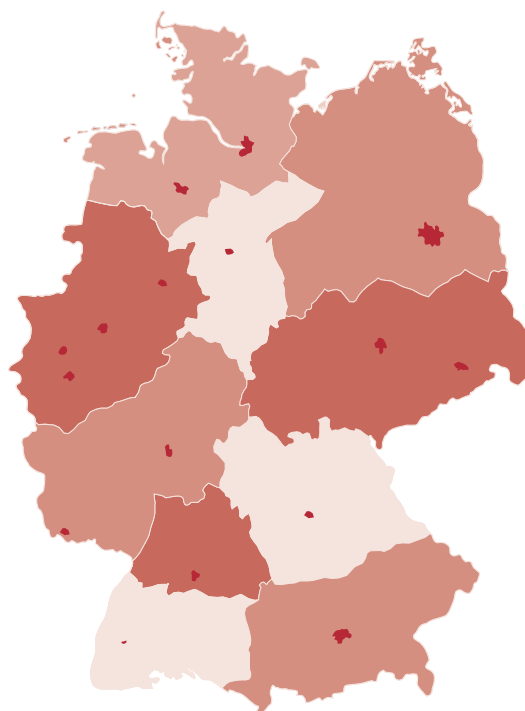

HUGRO products

Produktgruppe 1

Kabelverschraubungen

cable glands

Messing / Edelstahl
brass / stainless steel



Kunststoff
plastic



EMV
EMC



ATEX e / ATEX d
ATEX e / ATEX d



Hygiene
hygienic

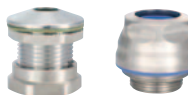

Mobilität
mobility



Produktgruppe 2

Kabelschutz

cable protection

Messing / Edelstahl
brass / stainless steel



Kunststoff
plastic



EMV-Systeme
EMC

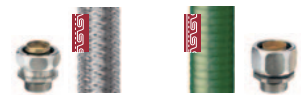

Ex-Systeme
ATEX



Schutzschläuche
hoses



Wellrohre
tubes

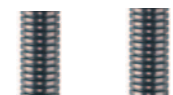

Halter
clips



HUGRO Services

HUGRO services

- **Persönliche Beratung**
- **Alternativen**
- **Optimierung**



**Optimale Verfügbarkeit
ab Lager
Waldkirch**

Produktgruppe 3
Zubehör
accessories

Druckausgleichselemente
pressure balance element



Entwässerungselemente
drainage element



Blindstopfen
stopping plugs



Reduktionen / Erweiterungen
reducers / enlargings



Gegenmuttern
lock nuts



O-Ringe / Flachringe
O-rings / flat sealing rings



Produktgruppe 4
Serien- und Sondergehäuse
standard and custom enclosures

- > mehr als 120 verschiedene Maße lieferbar
- > ab 1 Stück
- > in Edelstahl, Stahlblech und Polyester
- > ab Lager
- > wir fertigen nach Ihrer Zeichnung (alle gängigen Datenformate)
- > ab 1 Stück
- > in Edelstahl und Stahlblech

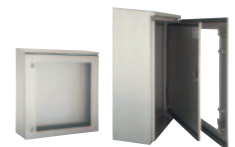

**Individuelle,
passgenaue
Kunden-
lösungen**



**Sicherheits-
lager mit Preis-
garantie bis 18
Monate**

Programm-Übersicht

Seriengehäuse

Stahlblech

| | | |
|-----------------------|--------------------------|----|
| • Elektronik Box | 1-türig | 8 |
| • Elektronik Box | 2-türig | 10 |
| • Elektronik Box | „breiter als hoch“ | 12 |
| • Elektronik Box AR | anreihbar | 14 |
| • Elektronik Box Plus | Standgehäuse | 16 |
| • Klemmgehäuse | | 18 |

Edelstahl

| | | |
|-------------------|-------|----|
| • VA Box | | 20 |
| • S2 Klemmgehäuse | | 22 |



Kunststoff

| | | |
|----------------|-------|-----|
| • Poly Box | | .24 |
| • Quattro Box | | .26 |
| • Nice Box | | .28 |
| • Terminal Box | | .30 |

| | | |
|----------------------|-------|-----|
| Sondergehäuse | | .32 |
|----------------------|-------|-----|

| | | |
|--------------------------------|-------|-----|
| Druckausgleichselemente | | .42 |
|--------------------------------|-------|-----|

| | | |
|------------------------------|-------|-----|
| Entwässerungselemente | | .42 |
|------------------------------|-------|-----|

| | | |
|---------------------------|-------|-----|
| Technischer Anhang | | .46 |
|---------------------------|-------|-----|



HUGRO Elektronik Box

HUGRO[®]
Qualität aus Waldkirch

1-türig Stahlblech-Gehäuse inkl. Montageplatte
Single door steel box included mounting plate



| | | | |
|---------------|--|-------------|---|
| Material: | Kaltgewalztes Stahlblech gemäß EN10130 + A1 Eingeschäumte Polyurethandichtung | Material: | cold rolled steel sheet according to EN10130 + A1 foamed polyurethane seal |
| Beschichtung: | Gehärtete Polyester- Lackbeschichtung RAL 7035 matt | Coating: | hardened polyester paint coating RAL 7035 frosted |
| Schutzart: | IP 66 (1-türige Variante) | Protection: | IP 66 |

inklusive Montageplatte



ZUBEHÖR SIEHE SEITE 11 / ACCESSOIRES SEE PAGE 11

| Gehäuse / enclosure Größe / dimension (mm) | | | | | Montageplatte / mounting plate | | | Kabeleingang / cable entry | | Schlösser / locks | HUGRO No. |
|---|---|------|---|-----|-----------------------------------|---|------|-------------------------------|-----|----------------------|-----------------|
| H | x | B | x | T | H | x | B | D | E | | |
| Eintüriges Stahlblech Wandgehäuse | | | | | | | | | | | |
| 250 | x | 200 | x | 150 | 220 | x | 150 | 65 | 120 | 1 | 807.252015.00 |
| 250 | x | 250 | x | 150 | 220 | x | 200 | 65 | 120 | 1 | 807.252515.00 |
| 300 | x | 200 | x | 150 | 270 | x | 150 | 65 | 120 | 1 | 807.302015.00 |
| 300 | x | 250 | x | 150 | 270 | x | 200 | 65 | 120 | 1 | 807.302515.00 |
| 300 | x | 250 | x | 200 | 270 | x | 150 | 65 | 120 | 1 | 807.302520.00 |
| 300 | x | 300 | x | 150 | 270 | x | 200 | 65 | 185 | 1 | 807.303015.00 |
| 300 | x | 300 | x | 200 | 270 | x | 250 | 125 | 215 | 1 | 807.303020.00 |
| 300 | x | 400 | x | 150 | 270 | x | 250 | 65 | 285 | 1 | 807.304015.00 |
| 300 | x | 400 | x | 200 | 270 | x | 350 | 125 | 285 | 1 | 807.304020.00 |
| 400 | x | 300 | x | 150 | 370 | x | 350 | 65 | 185 | 1 | 807.403015.00 |
| 400 | x | 300 | x | 200 | 370 | x | 250 | 125 | 215 | 1 | 807.403020.00 |
| 400 | x | 400 | x | 150 | 370 | x | 250 | 65 | 285 | 1 | 807.404015.00 |
| 400 | x | 400 | x | 200 | 140 | x | 350 | 125 | 285 | 1 | 807.404020.00 |
| 400 | x | 400 | x | 250 | 370 | x | 300 | 125 | 285 | 1 | 807.404025.00 |
| 400 | x | 600 | x | 200 | 370 | x | 350 | 125 | 485 | 1 | 807.406020.00 |
| 400 | x | 600 | x | 250 | 370 | x | 550 | 125 | 485 | 1 | 807.406025.00 |
| 400 | x | 600 | x | 300 | 370 | x | 550 | 125 | 485 | 1 | 807.406030.00 |
| 500 | x | 300 | x | 150 | 470 | x | 550 | 65 | 185 | 2 | 807.503015.00 |
| 500 | x | 300 | x | 200 | 470 | x | 250 | 125 | 215 | 2 | 807.503020.00 |
| 500 | x | 300 | x | 250 | 470 | x | 250 | 125 | 215 | 2 | 807.503025.00 |
| 500 | x | 400 | x | 150 | 470 | x | 350 | 65 | 285 | 2 | 807.504015.00 |
| 500 | x | 400 | x | 200 | 470 | x | 350 | 125 | 285 | 2 | 807.504020.00 |
| 500 | x | 400 | x | 250 | 470 | x | 350 | 125 | 285 | 2 | 807.504025.00 |
| 500 | x | 400 | x | 300 | 470 | x | 350 | 125 | 285 | 2 | 807.504030.00 |
| 500 | x | 500 | x | 150 | 470 | x | 450 | 65 | 285 | 2 | 807.505015.00 |
| 500 | x | 500 | x | 200 | 470 | x | 450 | 125 | 385 | 2 | 807.505020.00 |
| 500 | x | 500 | x | 250 | 470 | x | 450 | 125 | 385 | 2 | 807.505025.00 |
| 500 | x | 500 | x | 300 | 470 | x | 450 | 125 | 385 | 2 | 807.505030.00 |
| 500 | x | 700 | x | 200 | 470 | x | 650 | 125 | 485 | 2 | 807.507020.00 |
| 600 | x | 400 | x | 150 | 570 | x | 350 | 65 | 285 | 2 | 807.604015.00 |
| 600 | x | 400 | x | 200 | 570 | x | 350 | 125 | 285 | 2 | 807.604020.00 |
| 600 | x | 400 | x | 250 | 570 | x | 350 | 125 | 285 | 2 | 807.604025.00 |
| 600 | x | 400 | x | 300 | 570 | x | 350 | 125 | 285 | 2 | 807.604030.00 |
| 600 | x | 500 | x | 150 | 570 | x | 450 | 65 | 285 | 2 | 807.605015.00 |
| 600 | x | 500 | x | 200 | 570 | x | 450 | 125 | 385 | 2 | 807.605020.00 |
| 600 | x | 500 | x | 250 | 570 | x | 450 | 125 | 385 | 2 | 807.605025.00 |
| 600 | x | 500 | x | 300 | 570 | x | 450 | 125 | 385 | 2 | 807.605030.00 |
| 600 | x | 600 | x | 200 | 570 | x | 550 | 125 | 485 | 2 | 807.606020.00 |
| 600 | x | 600 | x | 250 | 570 | x | 550 | 125 | 485 | 2 | 807.606025.00 |
| 600 | x | 600 | x | 300 | 570 | x | 550 | 125 | 485 | 2 | 807.606030.00 |
| 600 | x | 600 | x | 400 | 570 | x | 550 | 125 | 485 | 2 | 807.606040.00 |
| 600 | x | 800 | x | 300 | 570 | x | 700 | 125 | 685 | 2 | 807.608030.00 |
| 700 | x | 500 | x | 150 | 670 | x | 450 | 65 | 285 | 2 | 807.705015.00 |
| 700 | x | 500 | x | 200 | 670 | x | 450 | 125 | 385 | 2 | 807.705020.00 |
| 700 | x | 500 | x | 250 | 670 | x | 450 | 125 | 385 | 2 | 807.705025.00 |
| 700 | x | 500 | x | 300 | 670 | x | 450 | 125 | 385 | 2 | 807.705030.00 |
| 800 | x | 400 | x | 200 | 770 | x | 350 | 125 | 285 | 2 | 807.804020.00 |
| 800 | x | 400 | x | 250 | 770 | x | 350 | 125 | 285 | 2 | 807.804025.00 |
| 800 | x | 400 | x | 300 | 770 | x | 350 | 125 | 285 | 2 | 807.804030.00 |
| 800 | x | 600 | x | 200 | 770 | x | 550 | 125 | 485 | 2 | 807.806020.00 |
| 800 | x | 600 | x | 250 | 770 | x | 550 | 125 | 485 | 2 | 807.806025.00 |
| 800 | x | 600 | x | 300 | 770 | x | 550 | 125 | 485 | 2 | 807.806030.00 |
| 800 | x | 600 | x | 400 | 770 | x | 550 | 125 | 485 | 2 | 807.806040.00 |
| 800 | x | 800 | x | 200 | 770 | x | 750 | 125 | 685 | 2 | 807.808020.00 |
| 800 | x | 800 | x | 250 | 770 | x | 750 | 125 | 685 | 2 | 807.808025.00 |
| 800 | x | 800 | x | 300 | 770 | x | 750 | 125 | 685 | 2 | 807.808030.00 |
| 800 | x | 800 | x | 400 | 770 | x | 750 | 125 | 685 | 2 | 807.808040.00 |
| 800 | x | 1000 | x | 300 | 770 | x | 950 | 125 | 885 | 2 | 807.8010030.00 |
| 1000 | x | 600 | x | 250 | 970 | x | 550 | 125 | 485 | 3P | 807.1006025.00 |
| 1000 | x | 600 | x | 300 | 970 | x | 550 | 125 | 485 | 3P | 807.1006030.00 |
| 1000 | x | 600 | x | 400 | 970 | x | 550 | 125 | 485 | 3P | 807.1006040.00 |
| 1000 | x | 800 | x | 250 | 970 | x | 750 | 125 | 685 | 3P | 807.1008025.00 |
| 1000 | x | 800 | x | 300 | 970 | x | 750 | 125 | 685 | 3P | 807.1008030.00 |
| 1000 | x | 800 | x | 400 | 970 | x | 750 | 125 | 685 | 3P | 807.1008040.00 |
| 1000 | x | 1000 | x | 300 | 970 | x | 950 | 125 | 885 | 3P | 807.10010030.00 |
| 1200 | x | 600 | x | 250 | 1170 | x | 550 | 125 | 485 | 3P | 807.1206025.00 |
| 1200 | x | 600 | x | 300 | 1170 | x | 550 | 125 | 485 | 3P | 807.1206030.00 |
| 1200 | x | 600 | x | 400 | 1170 | x | 550 | 125 | 485 | 3P | 807.1206040.00 |
| 1200 | x | 800 | x | 300 | 1170 | x | 750 | 125 | 685 | 3P | 807.1208030.00 |
| 1200 | x | 800 | x | 400 | 1170 | x | 750 | 125 | 685 | 3P | 807.1208040.00 |
| 1200 | x | 900 | x | 300 | 1170 | x | 850 | 120 | 685 | 3P | 807.1209030.00 |
| 1200 | x | 1000 | x | 300 | 1170 | x | 910 | 125 | 885 | 3P | 807.12010030.00 |
| 1200 | x | 1200 | x | 250 | 1170 | x | 1150 | 2x125 | 485 | 3P | 807.12012025.00 |
| 1400 | x | 600 | x | 300 | 1370 | x | 550 | 125 | 485 | 3P | 807.1406030.00 |
| 1400 | x | 600 | x | 400 | 1370 | x | 550 | 125 | 485 | 3P | 807.1406040.00 |
| 1400 | x | 800 | x | 300 | 1370 | x | 750 | 125 | 685 | 3P | 807.1408030.00 |
| 1400 | x | 800 | x | 400 | 1370 | x | 750 | 125 | 685 | 3P | 807.1408040.00 |

HUGRO Elektronik Box 2-türig

HUGRO[®]
Qualität aus Waldkirch

2-türig Stahlblech-Gehäuse inkl. Montageplatte
Twin door steel box incl. mounting plate



| | | | |
|---------------|---|-------------|--|
| Material: | Kaltgewalztes Stahlblech gemäß EN10130 + A1 Eingeschäumte Polyurethandichtung | Material: | cold rolled steel sheet according to EN10130 + A1 foamed polyurethane seal |
| Beschichtung: | Gehärtete Polyester-Lackbeschichtung RAL 7035 matt | Coating: | hardened polyester paint coating RAL 7035 frosted |
| Schutzart: | IP 55 (2-türige Variante) | Protection: | IP 55 |



inklusive Montageplatte



| Gehäuse / enclosure Größe / dimension (mm) | | | | | Montageplatte / mounting plate | | | Kabeleingang / cable entry | | Schlösser / locks | HUGRO No. |
|---|---|------|---|-----|-----------------------------------|---|------|-------------------------------|-----|----------------------|-----------------|
| H | x | B | x | T | H | x | B | D | E | | |
| Zweitüriges Stahlblech Wandgehäuse | | | | | | | | | | | |
| 800 | x | 1000 | x | 200 | 770 | x | 950 | 125 | 885 | 3P | 807.8010020.01 |
| 800 | x | 1000 | x | 300 | 770 | x | 950 | 125 | 885 | 3P | 807.8010030.01 |
| 800 | x | 1000 | x | 400 | 770 | x | 950 | 125 | 885 | 3P | 807.8010040.01 |
| 800 | x | 1200 | x | 300 | 770 | x | 1150 | 2x125 | 485 | 3P | 807.8012030.01 |
| 800 | x | 1200 | x | 400 | 770 | x | 1150 | 2x125 | 485 | 3P | 807.8012040.01 |
| 1000 | x | 1000 | x | 300 | 970 | x | 950 | 125 | 885 | 3P | 807.10010030.01 |
| 1000 | x | 1000 | x | 400 | 970 | x | 950 | 125 | 885 | 3P | 807.10010040.01 |
| 1000 | x | 1200 | x | 300 | 970 | x | 1150 | 2x125 | 485 | 3P | 807.10012030.01 |
| 1000 | x | 1200 | x | 400 | 1170 | x | 910 | 2x125 | 485 | 3P | 807.10012040.01 |
| 1200 | x | 1000 | x | 300 | 1170 | x | 910 | 125 | 885 | 3P | 807.12010030.01 |
| 1200 | x | 1000 | x | 400 | 1170 | x | 910 | 125 | 885 | 3P | 807.12010040.01 |
| 1200 | x | 1200 | x | 250 | 1170 | x | 1150 | 2x125 | 485 | 3P | 807.12012025.01 |
| 1200 | x | 1200 | x | 300 | 1170 | x | 1150 | 2x125 | 485 | 3P | 807.12012030.01 |
| 1200 | x | 1200 | x | 400 | 1170 | x | 1150 | 2x125 | 485 | 3P | 807.12012040.01 |
| 1400 | x | 1000 | x | 300 | 1370 | x | 950 | 125 | 885 | 3P | 807.14010030.01 |
| 1400 | x | 1000 | x | 400 | 1370 | x | 950 | 125 | 885 | 3P | 807.14010040.01 |
| 1400 | x | 1200 | x | 400 | 1370 | x | 950 | 2x125 | 485 | 3P | 807.14012040.01 |

Auf Anfrage mit Sichttüre aus gehärtetem Glas 4 mm

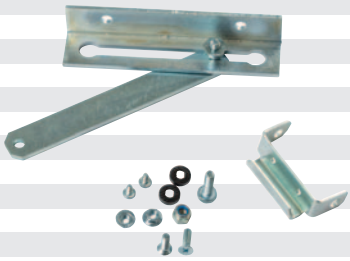
Transparent glass front on demand

| Wandbefestigung / Wall mounting brackets | Türarretierung / Door stay | Regendach / Rain coer |
|---|--|---|
| HUGRO No. | Größe / dimension B x H (mm) | auf Anfrage / upon request |
| 807.1000.WB | <250 bis 1200 | 807.1000.TA |
| Material: Stahlblech verzinkt Material: steel sheet galvanized | Material: Stahlblech verzinkt Material: steel sheet galvanized | |
|  |  |  |
| | | WEITERES ZUBEHÖR AUF ANFRAGE / ADDITIONAL ACCESSOIRES ON REQUEST |

HUGRO Elektronik Box

HUGRO[®]
Qualität aus Waldkirch

„breiter als hoch“ Stahlblech-Gehäuse inkl. Montageplatte
„wider than high“ steel enclosure incl. mounting plate



| | | | |
|---------------|--|-------------|--|
| Material: | Kaltgewalztes Stahlblech gemäß EN10130 + A1 Eingeschäumte Polyurethandichtung | Material: | cold rolled steel sheet according to EN10130 + A1 foamed polyurethane seal |
| Beschichtung: | Gehärtete Polyester-Lackbeschichtung RAL 7035 matt | Coating: | hardened polyester paint coating RAL 7035 frosted |
| Schutzart: | IP 66 (Eintürige Variante) / IP 55 (Zweitürige Variante) | Protection: | IP 66 / IP 55 |

inklusive Montageplatte

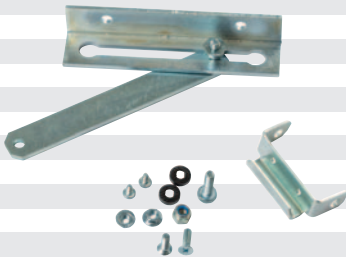

| Gehäuse / enclosure | | | | | Montageplatte / mounting plate (mm) | | | Kabeleingang / cable entry | | | Schlösser / locks | HUGRO No. |
|------------------------|---|------|---|-----|-------------------------------------|---|------|----------------------------|---|-----|-------------------|----------------|
| Größe / dimension (mm) | | | | | H x B | | | D E | | | | |
| H | x | B | x | T | H | x | B | D | E | | | |
| Version 1-türig | | | | | | | | | | | | |
| 500 | x | 800 | x | 250 | 470 | x | 750 | 125 | x | 685 | 2 | 807.508025.00 |
| 500 | x | 800 | x | 300 | 470 | x | 750 | 125 | x | 685 | 2 | 807.508030.00 |
| 600 | x | 800 | x | 250 | 570 | x | 750 | 125 | x | 685 | 2 | 807.608025.00 |
| 600 | x | 800 | x | 300 | 570 | x | 750 | 125 | x | 685 | 2 | 807.608030.00 |
| Version 2-türig | | | | | | | | | | | | |
| 500 | x | 1000 | x | 250 | 470 | x | 950 | 125 | x | 885 | Dreipunkt | 807.5010025.01 |
| 500 | x | 1000 | x | 300 | 470 | x | 950 | 125 | x | 885 | Dreipunkt | 807.5010030.01 |
| 600 | x | 1000 | x | 250 | 570 | x | 950 | 125 | x | 885 | Dreipunkt | 807.6010025.01 |
| 600 | x | 1000 | x | 300 | 570 | x | 950 | 125 | x | 885 | Dreipunkt | 807.6010030.01 |
| 500 | x | 1200 | x | 250 | 470 | x | 1150 | 2x125 | x | 485 | Dreipunkt | 807.5012025.01 |
| 500 | x | 1200 | x | 300 | 470 | x | 1150 | 2x125 | x | 485 | Dreipunkt | 807.5012030.01 |
| 600 | x | 1200 | x | 250 | 570 | x | 1150 | 2x125 | x | 485 | Dreipunkt | 807.6012025.01 |
| 600 | x | 1200 | x | 300 | 570 | x | 1150 | 2x125 | x | 485 | Dreipunkt | 807.6012030.01 |

| Wandbefestigung / Wall mounting brackets | | Türarretierung / Door stay | |
|---|--|--|--|
| HUGRO No. | | Größe / dimension (mm) | |
| | | B x H | |
| 807.1000.WB | | <250 bis 1200 | |
| 807.1000.WB | | 807.1000.TA | |
| Material: Stahlblech verzinkt Material: steel sheet galvanized | | Material: Stahlblech verzinkt Material: steel sheet galvanized | |
|  | |  | |

HUGRO Elektronik Box AR

HUGRO[®]
Qualität aus Waldkirch

Anreihbares Stahlblech-Gehäuse inkl. Montageplatte
Stackable steel enclosure incl. mounting plate



| | | | |
|---------------|--|-------------|---|
| Material: | Kaltgewalztes Stahlblech gemäß EN10130 + A1 Eingeschäumte Polyurethandichtung | Material: | cold rolled steel sheet according to EN10130 + A1 foamed polyurethane seal |
| Beschichtung: | Gehärtete Polyester- Lackbeschichtung RAL 7035 | Coating: | hardened polyester paint coating RAL 7035 |
| Schutzart: | IP 54 | Protection: | IP 54 |

inklusive Montageplatte



| Größe / dimension (mm) | | | | | Montageplatte / mounting plate | | | Schlösser / | Türen / | HUGRO No. |
|---|---|------|---|-----|--------------------------------|---|------|-------------|---------|----------------|
| H | x | B | x | T | H | x | B | locks | doors | |
| Gehäuse / enclosure | | | | | | | | | | |
| 600 | | 500 | | 400 | 570 | | 450 | 1 | 1 | 827.605040.01 |
| 600 | | 600 | | 400 | 570 | | 550 | 1 | 1 | 827.606040.01 |
| 600 | | 800 | | 400 | 570 | | 750 | 1 | 1 | 827.608040.01 |
| 600 | | 1000 | | 400 | 570 | | 950 | 3P | 2 | 827.6010040.01 |
| 600 | | 1200 | | 400 | 570 | | 1150 | 3P | 2 | 827.6012040.01 |
| Seitenwand (Paar) / side wall plate (couple) | | | | | | | | | | |
| 600 | | 400 | | | | | | | | 827.6040.01 |

Kombinationsbeispiele beliebig fortsetzbar in einem Breitenraster von 100 mm

Combination examples can be continued at will in a width grid of 100 mm

1100 mm



1200 mm



1300 mm



1400 mm



1500 mm



1600 mm



1700 mm

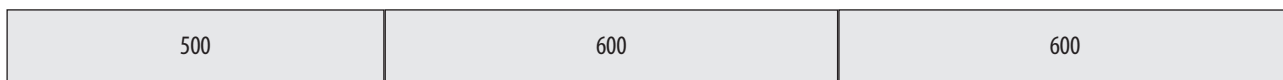

1800 mm



HUGRO Elektronik Box Plus

HUGRO[®]
Qualität aus Waldkirch

Stahlblech-Standschränke inkl. Montageplatte 3mm
Sheet steel standing cabinets incl. 3mm mounting plate



| | | | |
|--------------|--|------------|---|
| Material | Kaltgewalztes Stahlblech gemäß EN10130+A1 Eingeschäumte Polyurethandichtung | Material | Cold rolled steel sheet according to EN10130 + A1 Foamed polyurethane seal |
| Beschichtung | Gehärtete Polyester-Lackbeschichtung RAL 7035 matt mit UV-Schutz | Coating | Hardened polyester paint coating RAL 7035 matt with UV protection |
| Schutzart | IP65* (Eintürige Variante) IP55** (Zweitürige Variante) | Protection | IP65* IP55** |

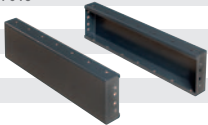

| Gehäuse / enclosure Größe / dimension (mm) | | | | | Montageplatte / mounting plate | | | Kabeleingang / cable entry | | Schlösser / locks | HUGRO No. | |
|---|---|------|---|-----|-----------------------------------|---|------|-------------------------------|---|----------------------|-----------|-----------------|
| H | x | B | x | T | H | x | B | D | E | | | |
| Eintüriges Stahlblech Standgehäuse IP65* / one-door sheet steel stand housing IP65* | | | | | | | | | | | | |
| 1650 | x | 600 | x | 400 | 1522 | x | 500 | 370 | x | 310 | 4P | 819.16506040.10 |
| 1650 | x | 800 | x | 400 | 1522 | x | 700 | 570 | x | 310 | 4P | 819.16508040.10 |
| 1650 | x | 1000 | x | 400 | 1522 | x | 900 | 770 | x | 310 | 4P | 819.16510040.10 |
| 1800 | x | 600 | x | 400 | 1672 | x | 500 | 370 | x | 310 | 4P | 819.18006040.10 |
| 1800 | x | 800 | x | 400 | 1672 | x | 700 | 570 | x | 310 | 4P | 819.18008040.10 |
| 1800 | x | 800 | x | 500 | 1672 | x | 700 | 570 | x | 410 | 4P | 819.18008050.10 |
| 1800 | x | 1000 | x | 400 | 1672 | x | 900 | 770 | x | 310 | 4P | 819.18010040.10 |
| 1800 | x | 1000 | x | 500 | 1672 | x | 900 | 770 | x | 410 | 4P | 819.18010050.10 |
| 2000 | x | 600 | x | 400 | 1872 | x | 500 | 370 | x | 310 | 4P | 819.20006040.10 |
| 2000 | x | 800 | x | 400 | 1872 | x | 700 | 570 | x | 310 | 4P | 819.20008040.10 |
| 2000 | x | 800 | x | 500 | 1872 | x | 700 | 570 | x | 410 | 4P | 819.20008050.10 |
| 2000 | x | 1000 | x | 400 | 1872 | x | 900 | 770 | x | 310 | 4P | 819.20010040.10 |
| 2000 | x | 1000 | x | 500 | 1872 | x | 900 | 770 | x | 410 | 4P | 819.20010050.10 |
| Zweitüriges Stahlblech Standgehäuse IP55** / two-door sheet steel stand housing IP55** | | | | | | | | | | | | |
| 1650 | x | 1000 | x | 400 | 1522 | x | 900 | 770 | x | 310 | 2P | 819.16510040.11 |
| 1650 | x | 1200 | x | 400 | 1522 | x | 1100 | 970 | x | 310 | 2P | 819.16512040.11 |
| 1800 | x | 1000 | x | 400 | 1672 | x | 900 | 770 | x | 310 | 2P | 819.18010040.11 |
| 1800 | x | 1000 | x | 500 | 1672 | x | 900 | 770 | x | 410 | 2P | 819.18010050.11 |
| 1800 | x | 1200 | x | 400 | 1672 | x | 1100 | 970 | x | 310 | 2P | 819.18012040.11 |
| 1800 | x | 1200 | x | 500 | 1672 | x | 1100 | 970 | x | 410 | 2P | 819.18012050.11 |
| 2000 | x | 1000 | x | 400 | 1872 | x | 900 | 770 | x | 310 | 2P | 819.20010040.11 |
| 2000 | x | 1000 | x | 500 | 1872 | x | 900 | 770 | x | 410 | 2P | 819.20010050.11 |
| 2000 | x | 1200 | x | 400 | 1872 | x | 1100 | 970 | x | 310 | 2P | 819.20012040.11 |
| 2000 | x | 1200 | x | 500 | 1872 | x | 1100 | 970 | x | 410 | 2P | 819.20012050.11 |
| 2000 | x | 1600 | x | 400 | 1872 | x | 1500 | 2x 570 | x | 270 | 2P | 819.20016040.11 |
| 2000 | x | 1600 | x | 500 | 1872 | x | 1500 | 2x 570 | x | 270 | 2P | 819.20016050.11 |

| Sockel / Eckstücke und Frontblende / Corner pieces and front panel Größe / dimension (mm) | | | | Seitenblende für Sockel / Side panel Größe / dimension (mm) | | | | Bausatz Innenschloss / Inside lock kit Größe / dimension (mm) | | | |
|---|---|-----------|-----------------|--|---|-----------|------------------|--|--|---|--------------|
| B x H | | HUGRO No. | | H x T | | HUGRO No. | | H | | HUGRO No. | |
| 100 | x | 600 | 819.ZCL1060.00 | 100 | x | 400 | 819.TLZCL1040.00 | 1650 | | | 807.48483.HS |
| 100 | x | 800 | 819.ZCL1080.00 | 100 | x | 500 | 819.TLZCL1050.00 | 1800 | | | 807.48484.HS |
| 100 | x | 1000 | 819.ZCL10100.00 | Material: Stahlblech RAL7016 Material: Sheet steel RAL 7016 | | | | 2000 | | | 807.48485.HS |
| 100 | x | 1200 | 819.ZCL10120.00 | | | | | Griff aus Polyamid mit Glasfaser Inside lock kit | |  | |
| Material: Stahlblech RAL7016 Material: Sheet steel RAL 7016 | | | |  | | | | | | | |
| * Zur Erreichung der Schutzart IP65 ist das Isolierkit 819.48690.00 erforderlich | | | | | | | | | | | |
| ** Zur Erreichung der Schutzart IP55 ist ein internes Innenschloss Doppeltür erforderlich. (H=1650 Best Nr.:807.48483.HS; H=1800 Best Nr.:807.48484.HS; H=2000 Best Nr.:807.48485.HS) | | | | | | | | | | | |
| * The insulation kit 819.48690.00 is required to achieve degree of protection IP65 | | | | | | | | | | | |
| ** To achieve protection class IP55, an internal double door lock is required. (H = 1650 order number: 807.48483.HS; H = 1800 order number: 807.48484.HS; H = 2000 order number: 807.48485.HS) | | | | | | | | | | | |

* / ** FÜR AUSFÜHRUNG IN SCHUTZART 55/65 BENÖTIGT ES INNENSCHLOSS UND ISOLIERKIT / FOR PROTECTION 55/65 YOU NEED INTERNAL DOOR LOCK AND INSULATION KIT

HUGRO Klemmgehäuse

HUGRO[®]
Qualität aus Waldkirch

Stahlblech-Gehäuse mit Schraubverschluss
Steel enclosure, screw open close type



| | | | |
|---------------|--|-------------|--|
| Material: | Kaltgewalztes Stahlblech gemäß EN10130+A1 | Material: | cold rolled steel sheet according to EN10130 + A1 |
| Beschichtung: | Gehärtete Polyester-Lackbeschichtung RAL 7035 matt | Coating: | foamed polyurethane seal hardened polyester paint coating RAL 7035 frosted |
| Schutzart: | IP 65 | Protection: | IP 65 |



| Gehäuse / enclosure Größe / dimension (mm) | | | | | HUGRO No. |
|---|---|-----|---|-----|---------------|
| H | x | B | x | T | |
| 150 | x | 150 | x | 95 | 817.151509.00 |
| 200 | x | 150 | x | 95 | 817.201509.00 |
| 200 | x | 200 | x | 95 | 817.202009.00 |
| 300 | x | 150 | x | 95 | 817.301509.00 |
| 300 | x | 200 | x | 95 | 817.302009.00 |
| 400 | x | 200 | x | 95 | 817.402009.00 |
| 150 | x | 150 | x | 135 | 817.151513.00 |
| 200 | x | 150 | x | 135 | 817.201513.00 |
| 200 | x | 200 | x | 135 | 817.202013.00 |
| 300 | x | 150 | x | 135 | 817.301513.00 |
| 300 | x | 200 | x | 135 | 817.302013.00 |
| 300 | x | 300 | x | 135 | 817.303013.00 |
| 400 | x | 200 | x | 135 | 817.402013.00 |
| 400 | x | 300 | x | 135 | 817.403013.00 |
| 400 | x | 400 | x | 135 | 817.404013.00 |
| 500 | x | 200 | x | 135 | 817.502013.00 |
| 500 | x | 300 | x | 135 | 817.503013.00 |
| 600 | x | 200 | x | 135 | 817.602013.00 |
| 600 | x | 400 | x | 135 | 817.604013.00 |

| Montageplatte / Mounting plates für Gehäusegröße / for enclosure dimension | | | | | | | HUGRO No. |
|---|---|-----|-----|---|-----|-------------|-----------|
| B | x | H | H | x | B | | |
| 150 | x | 150 | 130 | x | 115 | 817.1515.SV | |
| 200 | x | 150 | 180 | x | 115 | 817.2015.SV | |
| 200 | x | 200 | 180 | x | 165 | 817.2020.SV | |
| 300 | x | 150 | 280 | x | 115 | 817.3015.SV | |
| 300 | x | 200 | 280 | x | 165 | 817.3020.SV | |
| 300 | x | 300 | 280 | x | 265 | 817.3030.SV | |
| 400 | x | 200 | 380 | x | 165 | 817.4020.SV | |
| 400 | x | 300 | 380 | x | 165 | 817.4030.SV | |
| 400 | x | 400 | 380 | x | 365 | 817.4040.SV | |
| 500 | x | 200 | 480 | x | 165 | 817.5020.SV | |
| 500 | x | 300 | 480 | x | 265 | 817.5030.SV | |
| 600 | x | 200 | 580 | x | 165 | 817.6020.SV | |
| 600 | x | 300 | 580 | x | 265 | 817.6030.SV | |
| 600 | x | 400 | 580 | x | 365 | 817.6040.SV | |

| Wandbefestigung / Wall mounting brackets | HUGRO No. |
|--|-----------|
|--|-----------|

| | |
|--|-------------|
| | 807.1000.WB |
|--|-------------|



HUGRO VA Box

HUGRO[®]
Qualität aus Waldkirch

Edelstahl-Gehäuse inkl. Montageplatte Stainless steel enclosure included mounting plate



Material: Edelstahl 1.4306
Eingeschäumte
Polyurethandichtung
Beschichtung: Satiniert mit Scotch320
Schutzart: IP 66



Material: stainless steel 1.4306
foamed polyurethane seal
Coating: satin with Scotch320
Protection: IP 66

inklusive Montageplatte

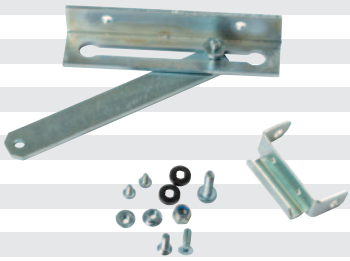

| Gehäuse / enclosure Größe / dimension (mm) | | | | | Montageplatte / mounting plate | | | Schlösser / locks | HUGRO No. |
|---|---|------|---|-----|--------------------------------|---|-----|----------------------|-----------------|
| H | x | B | x | T | H | x | B | | |
| 300 | x | 200 | x | 150 | 270 | x | 150 | 1 | 830.302015.43 |
| 300 | x | 250 | x | 150 | 270 | x | 200 | 1 | 830.302515.43 |
| 300 | x | 300 | x | 150 | 270 | x | 250 | 1 | 830.303015.43 |
| 400 | x | 300 | x | 200 | 370 | x | 250 | 1 | 830.403020.43 |
| 400 | x | 400 | x | 200 | 370 | x | 350 | 1 | 830.404020.43 |
| 400 | x | 600 | x | 200 | 370 | x | 550 | 1 | 830.406020.43 |
| 500 | x | 400 | x | 200 | 470 | x | 350 | 2 | 830.504020.43 |
| 500 | x | 400 | x | 250 | 470 | x | 350 | 2 | 830.504025.43 |
| 600 | x | 400 | x | 200 | 570 | x | 350 | 2 | 830.604020.43 |
| 600 | x | 500 | x | 250 | 570 | x | 450 | 2 | 830.605025.43 |
| 600 | x | 600 | x | 250 | 570 | x | 550 | 2 | 830.606025.43 |
| 700 | x | 500 | x | 250 | 670 | x | 450 | 2 | 830.705025.43 |
| 800 | x | 600 | x | 300 | 770 | x | 550 | 2 | 830.806030.43 |
| 800 | x | 800 | x | 300 | 770 | x | 750 | 2 | 830.808030.43 |
| 1000 | x | 800 | x | 300 | 970 | x | 750 | 3P | 830.1008030.43 |
| 1000 | x | 1000 | x | 300 | 970 | x | 950 | 3P | 830.10010030.43 |
| 1200 | x | 1000 | x | 300 | 1170 | x | 910 | 3P | 830.12010030.43 |

| | | | | | | | | | |
|--|--|--|--|--|--|--|--|--|--|
| | | | | | | | | | |
| | | | | | | | | | |
| | | | | | | | | | |
| | | | | | | | | | |
| | | | | | | | | | |
| | | | | | | | | | |
| | | | | | | | | | |
| | | | | | | | | | |
| | | | | | | | | | |

| Wandbefestigung / Wall mounting brackets | Türarretierung / Door stay | Regendach / Rain coer |
|---|--|---|
| HUGRO No. | Größe / dimension (mm) B x H | auf Anfrage / upon request |
| 807.1044.WB | <250 bis 1200 | 807.1044.TA |
| Material: Stahlblech verzinkt Material: steel sheet galvanized | Material: Stahlblech verzinkt Material: steel sheet galvanized | |
|  |  |  |
| | | WEITERES ZUBEHÖR AUF ANFRAGE / ADDITIONAL ACCESSOIRES ON REQUEST |

HUGRO S2 Klemmgehäuse

HUGRO[®]
Qualität aus Waldkirch

Edelstahl-Gehäuse mit Schraubverschluss
Stainless steel enclosure, screw open-close type



Material: Edelstahl 1.4306
Eingeschäumte
Polyurethandichtung
Beschichtung: Satiniert mit Scotch320
Schutzart: IP 66

Material: stainless steel 1.4306
foamed polyurethane seal
Coating: satin with Scotch320
Protection: IP 66



| Gehäuse / enclosure Größe / dimension (mm) | | | | | HUGRO No. |
|---|---|-----|---|-----|---------------|
| H | x | B | x | T | |
| 150 | x | 150 | x | 95 | 817.151509.43 |
| 200 | x | 150 | x | 95 | 817.201509.43 |
| 200 | x | 200 | x | 95 | 817.202009.43 |
| 300 | x | 150 | x | 95 | 817.301509.43 |
| 300 | x | 200 | x | 95 | 817.302009.43 |
| 400 | x | 200 | x | 95 | 817.402009.43 |
| 150 | x | 150 | x | 135 | 817.151513.43 |
| 200 | x | 150 | x | 135 | 817.201513.43 |
| 200 | x | 200 | x | 135 | 817.202013.43 |
| 300 | x | 150 | x | 135 | 817.301513.43 |
| 300 | x | 200 | x | 135 | 817.302013.43 |
| 300 | x | 300 | x | 135 | 817.303013.43 |
| 400 | x | 200 | x | 135 | 817.402013.43 |
| 400 | x | 300 | x | 135 | 817.403013.43 |
| 400 | x | 400 | x | 135 | 817.404013.43 |
| 500 | x | 200 | x | 135 | 817.502013.43 |
| 500 | x | 300 | x | 135 | 817.503013.43 |

| Montageplatte / Mounting plates für Gehäusegröße / for enclosure dimension (mm) | | | | | | | HUGRO No. |
|--|---|-----|-----|---|-----|-------------|-----------|
| B | x | H | H | x | B | | |
| 150 | x | 150 | 130 | x | 115 | 817.1515.SV | |
| 200 | x | 150 | 180 | x | 115 | 817.2015.SV | |
| 200 | x | 200 | 180 | x | 165 | 817.2020.SV | |
| 300 | x | 150 | 280 | x | 115 | 817.3015.SV | |
| 300 | x | 200 | 280 | x | 165 | 817.3020.SV | |
| 300 | x | 300 | 280 | x | 265 | 817.3030.SV | |
| 400 | x | 200 | 380 | x | 165 | 817.4020.SV | |
| 400 | x | 300 | 380 | x | 165 | 817.4030.SV | |
| 400 | x | 400 | 380 | x | 365 | 817.4040.SV | |
| 500 | x | 200 | 480 | x | 165 | 817.5020.SV | |
| 500 | x | 300 | 480 | x | 265 | 817.5030.SV | |
| 600 | x | 200 | 580 | x | 165 | 817.6020.SV | |
| 600 | x | 300 | 580 | x | 265 | 817.6030.SV | |
| 600 | x | 400 | 580 | x | 365 | 817.6040.SV | |

| Wandbefestigung / Wall mounting brackets | HUGRO No. |
|--|-----------|
|--|-----------|

807.1044.WB

Material: Edelstahl 1.4404
Material: stainless steel 1.4404



Poly Box

Polyester-Gehäuse Polyester enclosure



Material: Polyester
Schutzart: IP 66

mit integriertem Regenabweiser
Wasser und Abwasser beständig

└ Position Scharnier

Material: fibreglass
Rating: IP 66

with integrated rain shield
Water and waste water treatment

└ position draw latch

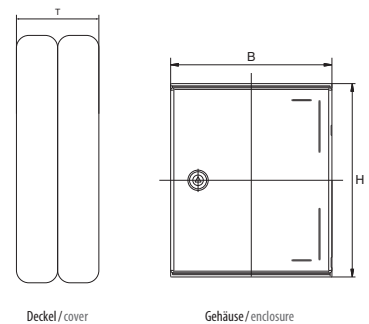

| Gehäuse / enclosure | | | | | HUGRO No. |
|------------------------|---|-----|---|-----|---------------|
| Größe / dimension (mm) | | | | | |
| H | x | B | x | T | |
| 300 | x | 250 | x | 140 | 850.253014.00 |
| 400 | x | 300 | x | 200 | 850.304020.00 |
| 400 | x | 400 | x | 200 | 850.404020.00 |
| 500 | x | 400 | x | 200 | 850.405020.00 |
| 600 | x | 400 | x | 230 | 850.406023.00 |
| 600 | x | 500 | x | 230 | 850.506023.00 |
| 800 | x | 600 | x | 300 | 850.608030.00 |

Auf Anfrage: Gehäuse mit Sichttüre
Transparent glass front on demand

| Montageplatte* / Mounting plates* | | | | Wandbefestigung / Wall mounting brackets | Sicherheitsverschluss / Safety lock |
|-----------------------------------|---|-----|-------------|--|-------------------------------------|
| Größe / dimension (mm) | | | | HUGRO No. | HUGRO No. |
| H | x | B | HUGRO No. | | |
| 300 | x | 250 | 851.2530.SZ | 851.1000.WB | 851.1000.SC |
| 400 | x | 300 | 851.3040.SZ | | |
| 400 | x | 400 | 851.4040.SZ | | |
| 500 | x | 400 | 851.4050.SZ | | |
| 600 | x | 400 | 851.4060.SZ | | |
| 600 | x | 500 | 851.5060.SZ | | |
| 800 | x | 600 | 851.6080.SZ | | |

* Montageplatte aus Stahlblech verzinkt
* Mounting plates made of galvanized sheet steel

Hochwertiges Montagezubehör
separat erhältlich
High quality mounting-plate
available separately

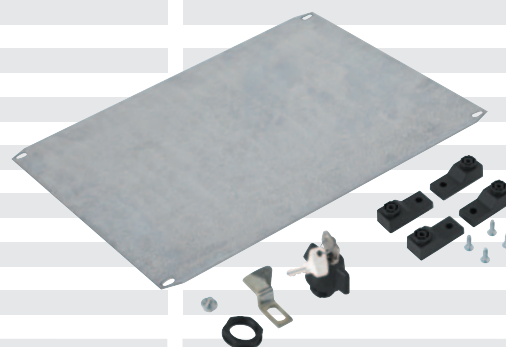

Quattro Box

Polycarbonat Gehäuse mit Schraubverschluss Polycarbonat enclosure, screw open-close type



Material: Polycarbonat
Farbe: RAL 7035
Deckel: grau oder transparent
Schutzart: IP 66
Schlagfestigkeit: IK 08
Einsatztemperatur: -40 °C to 85 °C

In Polycarbonat oder ABS lieferbar

Material: standard PC
Colour: RAL 7035
Cover: grey or clear
Rating: IP 66
Shock resistance: IK 08
Temperature range: -40 °C to 85 °C

In standard PC or ABS available

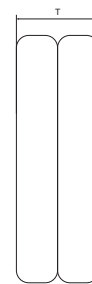

Deckel / cover

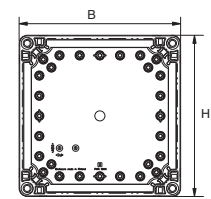

Gehäuse / enclosure



| Gehäuse / enclosure Größe / dimension (mm) | | | | | Deckel / cover | Gehäuse Unterteil / housing bottom part | HUGRO No. Deckel / cover grau / grey | HUGRO No. Deckel / cover transp. / clear |
|---|---|-----|---|-----|-------------------|--|--|--|
| H | x | B | x | T | T | T | | |
| 200 | x | 200 | x | 132 | 30 | 102 | 840.202013.00 | 840.202013.10 |
| 200 | x | 200 | x | 187 | 30 | 102+55 | 840.202018.00 * | 840.202018.10 * |
| 300 | x | 200 | x | 132 | 30 | 102 | 840.203013.00 | 840.203013.10 |
| 300 | x | 200 | x | 187 | 30 | 102+55 | 840.203018.00 * | 840.203018.10 * |
| 400 | x | 200 | x | 132 | 30 | 102 | 840.204013.00 | 840.204013.10 |
| 400 | x | 200 | x | 187 | 30 | 102+55 | 840.204018.00 * | 840.204018.10 * |
| 300 | x | 300 | x | 132 | 30 | 102 | 840.303013.00 | 840.303013.10 |
| 300 | x | 300 | x | 187 | 30 | 102+55 | 840.303018.00 * | 840.303018.10 * |
| 400 | x | 300 | x | 132 | 30 | 102 | 840.304013.00 | 840.304013.10 |
| 400 | x | 300 | x | 187 | 30 | 102+55 | 840.304018.00 * | 840.304018.10 * |
| 600 | x | 300 | x | 132 | 30 | 102 | 840.306013.00 | 840.306013.10 |
| 600 | x | 300 | x | 187 | 30 | 102+55 | 840.306018.00 * | 840.306018.10 * |
| 600 | x | 400 | x | 132 | 30 | 102 | 840.406013.00 | 840.406013.10 |
| 600 | x | 400 | x | 187 | 30 | 102+55 | 840.406018.00 * | 840.406018.10 * |

* Inklusive Zwischenrahmen
* intermediate frame included

| Montageplatte* / Mounting plates* | | | | Scharnier / Hinges | Scharnierschraube / Hinges | Wandbefestigung / Wal mounting brackets |
|-----------------------------------|---|-----|--|-----------------------|-------------------------------|--|
| Größe / dimension (mm) | | | | HUGRO No. | HUGRO No. | HUGRO No. |
| H | x | B | | | | |
| 200 | x | 200 | | 841.2020.SZ | 840.1000.SR | 841.1000.WB |
| 300 | x | 200 | | 841.2030.SZ | | |
| 400 | x | 200 | | 841.2040.SZ | | |
| 300 | x | 300 | | 841.3030.SZ | | |
| 400 | x | 300 | | 841.3040.SZ | | |
| 600 | x | 300 | | 841.3060.SZ | | |
| 600 | x | 400 | | 841.4060.SZ | | |

* Montageplatte aus Stahlblech verzinkt
* Mounting plates made of galvanized
sheet steel

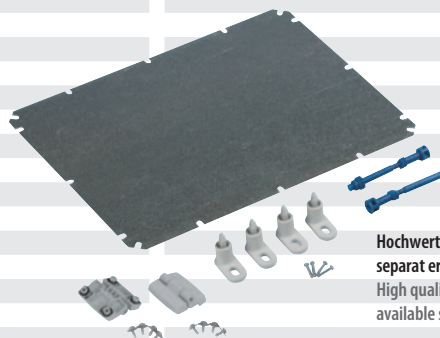

Hochwertiges Montagezubehör
separat erhältlich
High quality mounting-plate
available separately

Nice Box

HUGRO[®]
Qualität aus Waldkirch

Polycarbonat-Gehäuse mit Schnappschnellverschluss und Scharnieren Polycarbon enclosure with plastic draw latch and hinges



Material: Polycarbonat
Farbe: grau / RAL 7035
Deckel: grau oder transparent
Schutzart: IP 66
Schlagfestigkeit: IK 08 PC
Einsatztemperatur: -40 °C bis 85 °C

Material: standard PC
Colour: grey / RAL 7035
Cover: grey or clear
Rating: IP 66
Shock resistance: IK 08 PC
Temperature range: -40 °C to 85 °C

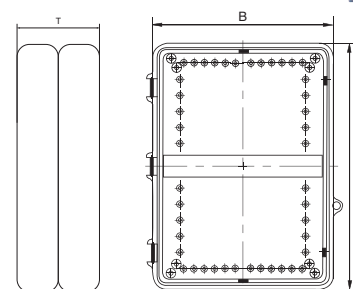

Deckel / cover

Gehäuse / enclosure

└ Position Scharnier

└ position draw latch

- Gehäuse mit angespritztem Scharnier und Schnappschnellverschluss
- Kunststofflochplatte für alle Gehäusegrößen lieferbar
- grauer oder transparenter Deckel
- Wandbefestigung inklusive
- einzigartige Schwalbenschwanzführung für Rahmen- oder Frontplatte / keine Distanzbolzen
- schwenkbare Aluminiumfrontplatte lieferbar
- Plombierung möglich
- Doppelbartschloss möglich
- Schraubendurchmesser für Montageplatte 3,5 mm

- Enclosure with plastic draw latch and hinges
- Plastic mounting panel for all enclosure sizes
- grey or clear cover
- Wall mounting brackets included
- Clip hinges in stead of distance bolt for PCB
- Aluminium swingout panel
- prepared for sealing
- double lock available
- Screw dimensions for the mounting panel 3,5 mm



| Gehäuse / enclosure Größe / dimension (mm) | | | | | HUGRO No. Deckel / cover grau / grey | HUGRO No. Deckel / cover transp. / clear |
|---|---|-----|---|-----|--|--|
| B | x | H | x | T | | |
| 100 | x | 150 | x | 70 | 801.101507.00 | 801.101507.10 |
| 100 | x | 270 | x | 70 | 801.102707.00 | 801.102707.10 |
| 150 | x | 150 | x | 90 | 801.151509.00 | 801.151509.10 |
| 170 | x | 220 | x | 110 | 801.172211.00 | 801.172211.10 |
| 170 | x | 220 | x | 130 | 801.172213.00 | 801.172213.10 |
| 170 | x | 270 | x | 110 | 801.172711.00 | 801.172711.10 |
| 170 | x | 270 | x | 130 | 801.172713.00 | 801.172713.10 |
| 190 | x | 290 | x | 100 | 801.192910.00 | 801.192910.10 |
| 190 | x | 290 | x | 140 | 801.192914.00 | 801.192914.10 |
| 250 | x | 300 | x | 180 | 801.253018.00 | 801.253018.10 |
| 250 | x | 350 | x | 150 | 801.253515.00 | 801.253515.10 |
| 290 | x | 190 | x | 100 | 801.291910.00 | 801.291910.10 |
| 290 | x | 190 | x | 140 | 801.291914.00 | 801.291914.10 |
| 290 | x | 390 | x | 100 | 801.293910.00 | 801.293910.10 |
| 290 | x | 390 | x | 140 | 801.293914.00 | 801.293914.10 |
| 290 | x | 390 | x | 160 | 801.293916.00 | 801.293916.10 |
| 300 | x | 300 | x | 130 | 801.303013.00 | 801.303013.10 |
| 300 | x | 300 | x | 180 | 801.303018.00 | 801.303018.10 |
| 350 | x | 465 | x | 160 | 801.354616.00 | 801.354616.10 |
| 350 | x | 465 | x | 200 | 801.354620.00 | 801.354620.10 |
| 430 | x | 530 | x | 160 | 801.435316.00 | 801.435316.10 |
| 500 | x | 700 | x | 180 | 801.507018.00 | 801.507018.10 |
| 500 | x | 700 | x | 250 | 801.507025.00 | 801.507025.10 |

| passend für: suitable for: | Lochplatte / Mountingpanel Größe / dimension (mm) | | | | | HUGRO No. | Rahmen / Frame HUGRO No. | Frontplatten / Frontpanel HUGRO No. |
|-------------------------------|--|---|-----|---|------|-------------|-----------------------------|--|
| | B | x | H | x | T | | | |
| 801.101507.xx | 116 | x | 68 | x | 3,5 | 811.1015.LP | | |
| 801.102707.xx | 235 | x | 68 | x | 3,5 | 811.1027.LP | | |
| 801.151509.xx | 124 | x | 124 | x | 3,75 | 811.1515.LP | | |
| 801.1722xx.xx | 186 | x | 136 | x | 3,0 | 811.1722.LP | | |
| 801.1727xx.xx | 235 | x | 136 | x | 3,75 | 811.1727.LP | | |
| 801.253018.xx | 237 | x | 287 | x | 4,0 | 811.2530.LP | 821.2530.RN | 821.2530.FP |
| 801.253515.xx | 316 | x | 217 | x | 4,3 | 811.2535.LP | 821.2535.RN | 821.2535.FP |
| 801.2939xx.xx | 362 | x | 265 | x | 3,9 | 811.2939.LP | 821.2939.RN | 821.2939.FP |
| 801.3030xx.xx | 287 | x | 287 | x | 3,3 | 811.3030.LP | 821.3030.RN | 821.3030.FP |
| 801.3546xx.xx | 447 | x | 333 | x | 4,3 | 811.3546.LP | 821.3546.RN | 821.3546.FP |
| 801.4353xx.xx | 463 | x | 362 | x | 4,3 | 811.4353.LP | 821.4353.RN | 821.4353.FP |
| 801.5070xx.xx | 684 | x | 463 | x | 4,4 | 811.5070.LP | 821.5070.RN | 821.5070.FP |

Anmerkung: xx ist ein Platzhalter und gilt für die entsprechenden Gehäusetypen in der jeweiligen Größe
 Remark: xx stays for each enclosure / sizes

| Bezeichnung / description | passend für Gehäuse / for enclosures | passend für Rahmen / for frame | HUGRO No. |
|--|---|-----------------------------------|-------------|
| Befestigungsschrauben für Frontplatte / screw for frontpanel | | | 820.1000.BS |
| * Clip (klein, starr) / small | 801.101307.xx-801.151509.xx | | 820.1000.CN |
| Clip (groß, starr) / large | 801.1722xx.xx-801.5070xx.xx | | 820.5000.CN |
| Clip (beweglich) / movable | 801.1722xx.xx-801.5070xx.xx | | 820.5000.CS |
| Scharnier für Rahmen / hinges | 801.1929xx.xx-801.5070xx.xx | 821.1929.RN-821.5070.RN | 820.2500.SR |
| Wandbefestigung / wall mounting brackets | | | 820.4000.WB |
| Wandbefestigung / wall mounting brackets | | | 820.5000.WB |
| Wandbefestigung / wall mounting brackets | | | 820.6000.WB |
| * 1 Satz = 4 Stück / 1 set = 4 pieces | | | |

Terminal Box

HUGRO®
Qualität aus Waldkirch

Polycarbonat-Gehäuse mit Schraubverschluss Polycarbonat enclosure, screw open-close type

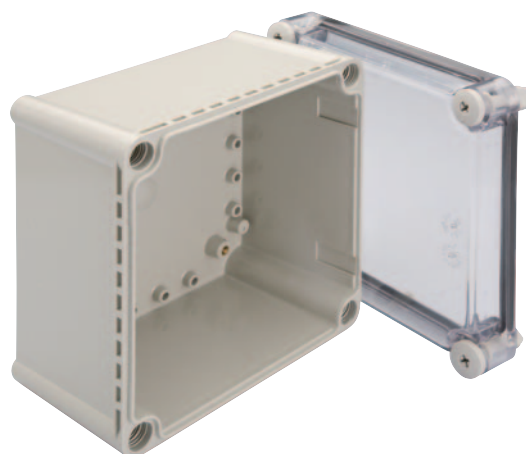

Material: Polycarbonat
Farbe: grau / RAL 7035
Deckel: grau oder transparent
Schutzart: IP 66
Schlagfestigkeit: IK 08 PC
Einsatztemperatur: -40 °C bis 85 °C

Material: standard PC
Colour: grey / RAL 7035
Cover: grey or clear
Rating: IP 66
Shock resistance: IK 08 PC
Temperature range: -40 °C to 85 °C

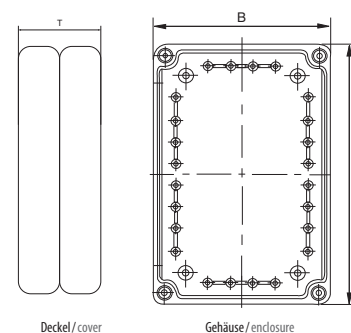

Deckel / cover

Gehäuse / enclosure

- Gehäuse mit Schraubverschluss
- Kunststofflochplatte für alle Gehäusegrößen lieferbar
- einzigartige Schwalbenschwanzführung für Rahmen- oder Frontplatte (keine Distanzbolzen)
- grauer oder transparenter Deckel
- schwenkbare Aluminiumfrontplatte lieferbar
- Erhöhungsrahmen (50 mm) für Tiefenänderung
- Schraubendurchmesser für Montageplatte 3,5 mm

- Enclosure, screw open-close type
- Plastic mounting panel for all enclosure sizes
- Clip hinges in stead of distance bolt for PCB
- grey or clear cover
- Aluminium swingout panel
- Extension frame (50 mm)
- Screw dimensions for the mounting panel 3,5 mm



| Gehäuse / enclosure Größe / dimension (mm) | | | | | HUGRO No. | HUGRO No. |
|---|---|-----|---|-----|-------------------------------|-----------------------------------|
| B | x | H | x | T | Deckel / cover grau / grey | Deckel / cover transp. / clear |
| 190 | x | 190 | x | 130 | 802.191913.00 | 802.191913.10 |
| 280 | x | 190 | x | 130 | 802.281913.00 | 802.281913.10 |
| 280 | x | 190 | x | 180 | 802.281918.00 | 802.281918.10 |
| 280 | x | 190 | x | 230 | 802.281923.00 | 802.281923.10 |
| 280 | x | 280 | x | 130 | 802.282813.00 | 802.282813.10 |
| 340 | x | 280 | x | 130 | 802.342813.00 | 802.342813.10 |
| 380 | x | 280 | x | 130 | 802.382813.00 | 802.382813.10 |
| 380 | x | 280 | x | 180 | 802.382818.00 | 802.382818.10 |
| 380 | x | 280 | x | 230 | 802.382823.00 | 802.382823.10 |
| 380 | x | 190 | x | 130 | 802.381913.00 | 802.381913.10 |
| 380 | x | 190 | x | 180 | 802.381918.00 | 802.381918.10 |
| 380 | x | 190 | x | 230 | 802.381923.00 | 802.381923.10 |
| 560 | x | 280 | x | 130 | 802.562813.00 | 802.562813.10 |
| 560 | x | 380 | x | 180 | 802.563818.00 | 802.563818.10 |

| passend für: suitable for: | Lochplatte / Mountingpanel Größe / dimension (mm) B x H x T | HUGRO No. | Rahmen / Frame | HUGRO No. | Erhöhungsrahmen / Extension frame 50 mm | HUGRO No. | Frontplatten für Rahmen Frontpanel for frame | HUGRO No. |
|-------------------------------|---|----------------------------|----------------|-------------|--|----------------------------|---|-----------|
| 802.191913.xx | 160 x 160 x 4,0 | 812.1919.LP | | | 822.1919.RV | | | |
| 802.2819xx.xx | 252 x 161 x 3,4 | 812.2819.LP | | 822.2819.RN | | | 822.2819.FP | |
| 802.282813.xx | 267 x 267 x 3,3 | 812.2828.LP | | 822.2828.RN | | 822.2828.RV | 822.2828.FP | |
| 802.342813.xx | 240 x 300 x 4,0 | 812.3428.LP | | | | | | |
| 802.3819xx.xx | 155 x 335 x 4,0 | 812.3819.LP | | | | | | |
| 802.3828xx.xx | 351 x 251 x 4,3 | 812.3828.LP 822.3828.FP | | 822.3828.RN | | 822.3828.RV | | |
| 802.562813.xx | | | | | | | | |
| 802.563813.xx | 267 x 267 x 3,3 (2x) 351 x 251 x 4,3 (2x) | 812.2828.LP 812.3828.LP | | | | 822.5628.RV 822.5638.RV | | |

Anmerkung: Erhöhungsrahmen kann verwendet bei nicht ausreichender Gehäusetiefe
 Remark: Extension frame used if higher size needed

Anmerkung: xx ist ein Platzhalter und gilt für die entsprechenden Gehäusetypen in der jeweiligen Größe
 Remark: xx stays for each enclosure / sizes

| Bezeichnung / description | passend für Gehäuse / for enclosures | passend für Rahmen / for frame | HUGRO No. |
|--|---|--|-------------|
| Befestigungsschrauben für Frontplatte / screw for frontpanel | | | 820.1000.BS |
| Clip (groß, starr) / large | 802.191913.xx-802.563818.xx | | 820.5000.CN |
| Clip (beweglich) / movable | 802.191913.xx-802.563818.xx | | 820.5000.CS |
| Scharnier für Rahmen / hinges | | 822.2819.RN, 822.2828.RN, 822.3828.RN | 820.2500.SR |
| Wandbefestigung / wall mounting brackets | 802.191913.xx-802.3828xx.xx | | 820.5000.WB |
| Wandbefestigung / wall mounting brackets | 802.562813.xx-802.563818.xx | | 820.6000.WB |

Sondergehäuse

Produktbeispiel Steuergehäuse Control enclosure

- >>> wir fertigen exakt nach Ihrer Zeichnung (alle gängigen Datenformate)
- >>> 1 Stück oder mehr
- >>> Edelstahl und Stahlblech

-
- >>> we produce according to your exact need (all data format)
 - >>> 1 single piece or more
 - >>> stainless steel or steel



Sondergehäuse

Produktbeispiel Klemmgehäuse mit Sichtscheibe
Terminal enclosure with window

- >>> mit kurzer Lieferzeit
- >>> persönlicher Beratung vor Ort
- >>> optional mit Bestückung

-
- >>> with short lead times
 - >>> personal call or individual guidance
 - >>> assembly as an option



Sondergehäuse

Produktbeispiel Wandgehäuse mit Vorbau
Wall enclosure with stem

- >>> wir fertigen exakt nach Ihrer Zeichnung (alle gängigen Datenformate)
- >>> 1 Stück oder mehr
- >>> Edelstahl und Stahlblech

-
- >>> we produce according to your exact need (all data format)
 - >>> 1 single piece or more
 - >>> stainless steel or steel



Sondergehäuse

Produktbeispiel Wandgehäuse mit Sondermaß
Wall enclosure according to custom sizes

- >>> mit kurzer Lieferzeit
- >>> persönlicher Beratung vor Ort
- >>> optional mit Bestückung

-
- >>> with short lead times
 - >>> personal call or individual guidance
 - >>> assembly as an option



Sondergehäuse

Produktbeispiel Wandgehäuse mit Sondermaß
Wall enclosure according to custom sizes

>>> wir fertigen exakt nach Ihrer Zeichnung (alle gängigen Datenformate)

>>> 1 Stück oder mehr

>>> Edelstahl und Stahlblech

>>> we produce according to your exact need (all data format)

>>> 1 single piece or more

>>> stainless steel or steel



Sondergehäuse

Produktbeispiel Schaltschrank mit Tür in Tür
Control enclosure with door in door

- >>> mit kurzer Lieferzeit
- >>> persönlicher Beratung vor Ort
- >>> optional mit Bestückung

-
- >>> with short lead times
 - >>> personal call or individual guidance
 - >>> assembly as an option



Sondergehäuse

Produktbeispiel Steuerschrank aus Edelstahl
Control enclosure in stainless steel

- >>> wir fertigen exakt nach Ihrer Zeichnung (alle gängigen Datenformate)
- >>> 1 Stück oder mehr
- >>> Edelstahl und Stahlblech

-
- >>> we produce according to your exact need (all data format)
 - >>> 1 single piece or more
 - >>> stainless steel or steel

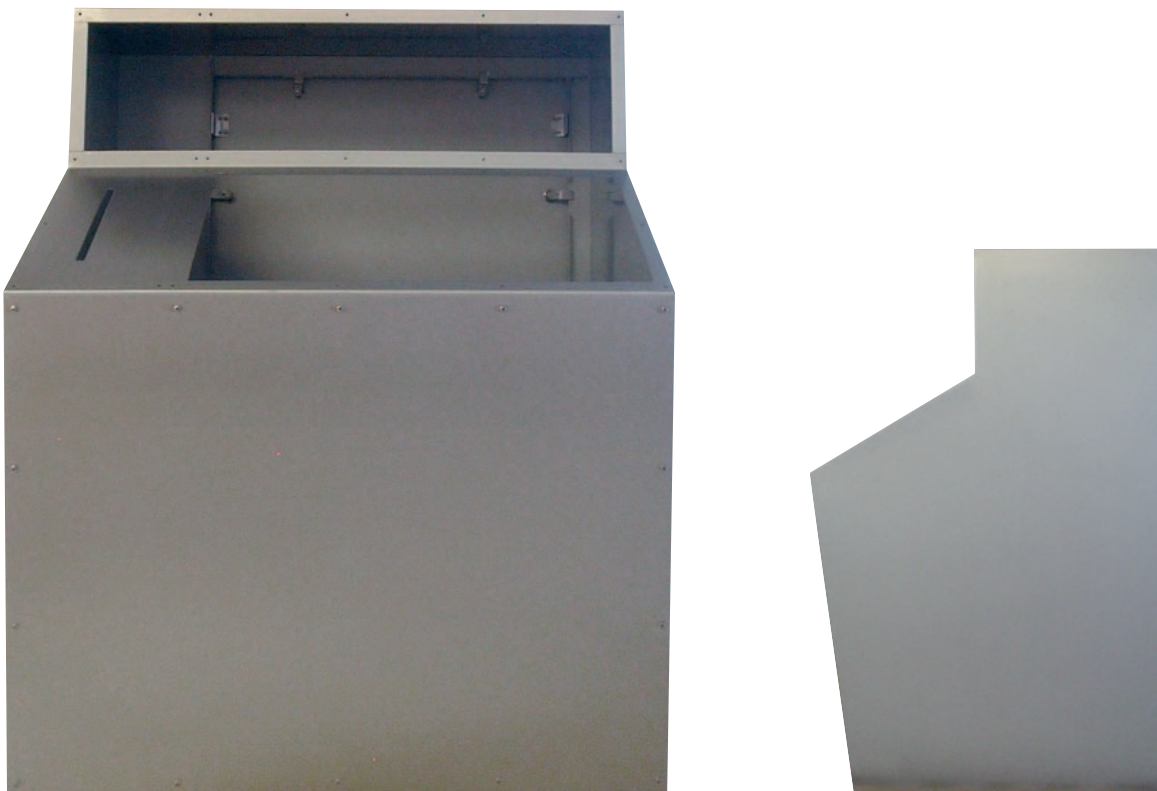

Sondergehäuse

Produktbeispiel Schaltschrank nach Sondermaß
The enclosure according to custom sizes

- >>> mit kurzer Lieferzeit
- >>> persönlicher Beratung vor Ort
- >>> optional mit Bestückung

-
- >>> with short lead times
 - >>> personal call or individual guidance
 - >>> assembly as an option



Sondergehäuse

Produktbeispiel „Alles was geht“
„No limit“



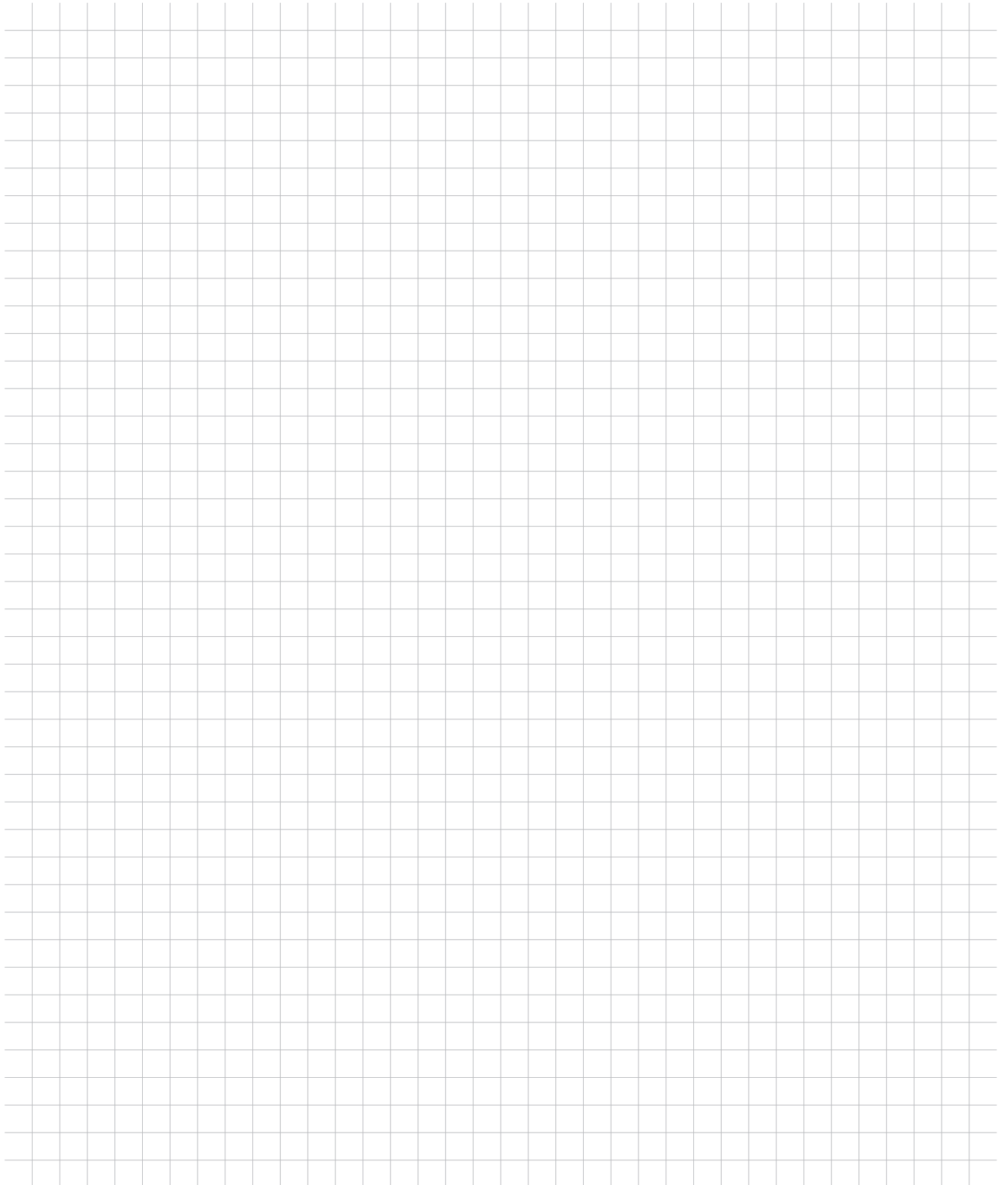

HUGRO-Gehäuse

Produziert mit höchster Qualität
Produced with the highest quality

>>> industrieller Fertigungsstandard
>>> umweltgerecht, resourceschonend

>>> high industrial standard
>>> environmentally, prevent resources



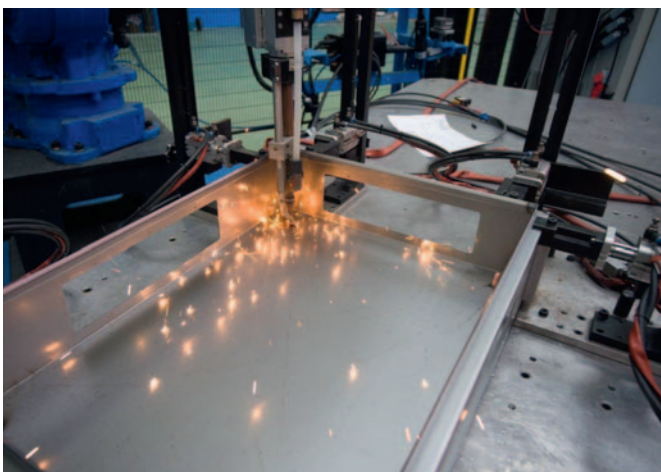

Druckausgleichselement mit Membrane

Pressure balance element with membrane

HUGRO®
Qualität aus Waldkirch

Material: PA (Polyamid)
Farbe: schwarz
O-Ring: NBR
Einsatztemperatur: -40° bis 100°C
Schutzart: IP 66 / IP 68 / IP 69K
Wassereintrittsdruck: > 12.0 psi / 0.83 bar
Luftdurchsatz: > 90ml / min / cm² bei 10 mbar

Material: PA (nylon)
Colour: black
O-ring: NBR
Temperature range: -40°C to 100°C
Protection type: IP 66 / IP 68 / IP69K
Water intrusion pressure: > 12.0 psi / 0.83 bar
Air flow rate: > 90ml / min / cm² at 10 mbar

595.AS

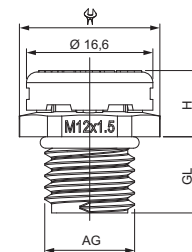

| Gewinde Thread AG |  | H mm | GL mm | HUGRO No. |
|-------------------------|---|---------|----------|-----------|
| M 12 x 1,5 | 17 | 9 | 10 | 595.15.AS |

Auf Anfrage: - in RAL 7035 **On request:** - in RAL 7035

Eigenschaften:
- halogenfrei
- UV-beständig (getestet nach EN ISO 4892-2)

Characteristics:
- halogen-free
- UV resistant (tested according to EN ISO 4898-2)



Entwässerungselement mit Sieb

Drainage element with mesh

Material: Messing vernickelt
Filterscheibe: Rostfreier Stahl A2
O-Ring: NBR
Einsatztemperatur: -50°C bis 110°C
Schutzart: IP 4x

Material: brass, nickel-plated
Membrane: stainless steel A2
O-ring: NBR
Temperature range: -50°C to 110°C
Protection type: IP 4x

556.ES

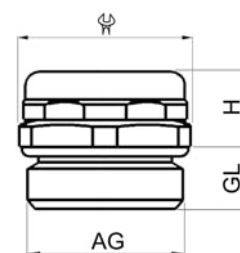

| Gewinde Thread AG |  | H mm | GL mm | HUGRO No. |
|-------------------------|---|---------|----------|-------------|
| M 12 x 1,5 | 18 | 9,5 | 10 | 556.15ES.00 |
| M 16 x 1,5 | 18 | 9,5 | 10 | 556.17ES.00 |
| M 20 x 1,5 | 22 | 10 | 10 | 556.20ES.00 |

Auf Anfrage: in Edelstahl 1.4305 oder 1.4435 **On request:** stainless steel 1.4305 or 1.4435

Passende Gegenmutter Serie 523.00 Lock nut series 523.00



Druckausgleichselement mit Membrane

Pressure balance element with membrane

HUGRO®
Qualität aus Waldkirch

Material: Messing vernickelt
Membrane: PES Polyethersulfon
O-Ring: NBR
Einsatztemperatur: -40°C bis 110°C
Schutzart: IP 66/IP 68/IP 69K
Wassereintrittsdruck: > 12,0 psi/0.83 bar
Luftdurchsatz: > 90ml/min/cm² bei 10 mbar

Material: brass, nickel-plated
Membrane: PES polyethersulfone
O-ring: NBR
Temperature range: -40°C to 110°C
Protection type: IP 66/IP 68/IP69K
Water intrusion pressure: > 12.0 psi/0.83 bar
Air flow rate: > 90ml/min/cm² at 10 mbar

556.PS

| Gewinde Thread AG |  mm | H mm | GL mm | HUGRO No. |
|-------------------------------------|---|--------------------------------------|----------|-------------|
| M 12 x 1,5 | 18 | 9,5 | 8 | 556.15PS.00 |
| M 16 x 1,5 | 18 | 9,5 | 8 | 556.17PS.00 |
| M 20 x 1,5 | 22 | 10 | 8 | 556.20PS.00 |
| Pg 7 | 18 | 9,5 | 8 | 556.07PS.00 |
| Pg 11 | 20 | 10 | 8 | 556.11PS.00 |
| Auf Anfrage: | | On request: | | |
| - für höhere Temperaturen bis 200°C | | - for higher temperature up to 200°C | | |
| - in Edelstahl 1.4305 oder 1.4435 | | - stainless steel 1.4305 or 1.4435 | | |

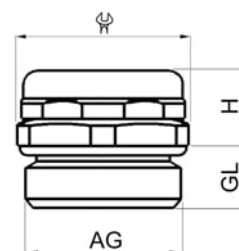

mit Sinterfilter

with sintered filter

Material: Messing vernickelt
Filterscheibe: Sinterbronze
O-Ring: NBR
Einsatztemperatur: -50°C bis 110°C
Schutzart: IP 54/IP x9K
Filtergrad: 40 µm

Material: brass, nickel-plated
Membrane: sintered bronze
O-ring: NBR
Temperature range: -50°C to 110°C
Protection type: IP 54/IP x9K
Degree of filter: 40 µm

556.SB

| Gewinde Thread AG |  mm | H mm | GL mm | HUGRO No. |
|-------------------------------------|---|--------------------------------------|----------|-------------|
| M 12 x 1,5 | 18 | 9,5 | 8 | 556.15SB.00 |
| M 16 x 1,5 | 18 | 9,5 | 8 | 556.17SB.00 |
| M 20 x 1,5 | 22 | 10 | 8 | 556.20SB.00 |
| Pg 7 | 18 | 9,5 | 8 | 556.07SB.00 |
| Pg 11 | 20 | 10 | 8 | 556.11SB.00 |
| Auf Anfrage: | | On request: | | |
| - für höhere Temperaturen bis 200°C | | - for higher temperature up to 200°C | | |
| - in Edelstahl 1.4305 oder 1.4435 | | - stainless steel 1.4305 or 1.4435 | | |

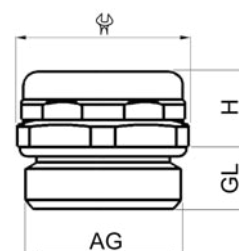

Material

| Polycarbonat (PC) | |
|--|---|
| + hohe Schlagfestigkeit | - durch den Einsatz von Glasfasern sind optimale Farbtonungen relativ schwierig |
| + hohe Schutzart | |
| + leicht | |
| + gute Chemikalienbeständigkeit | |
| + gute Temperaturbeständigkeit | |
| + selbstverlöschend | |
| + einfache Bearbeitung mit gewöhnlichem Werkzeug | |
| + gute Isoliereigenschaften | |
| + auch für den Außenbereich | |
| + UV-Beständigkeit | |
| + Halogenfrei | |

| Lackierter Stahl | |
|---|--------------------|
| + hohe Schlagfestigkeit | - Korrosionsrisiko |
| + hohe Schutzart | |
| + einfache, kundenspezifische Bearbeitung, Maße nach Wunsch möglich | |

| Rostfreier Stahl (AISI 304) | |
|--|---|
| + hohe Schlagfestigkeit | - teurer als lackiertes Stahlblech |
| + hohe Schutzart | - Bearbeitung schwieriger als bei lackiertem Stahlblech |
| + ausgezeichnete Korrosionsbeständigkeit | |
| + ausgezeichnete UV-Beständigkeit | |
| + geeignet für industrielles Umfeld | |
| + ideal zum Einsatz in der Lebensmittelindustrie | |

| Glasfaserverstärktes Polyester (GRP) | |
|---|--------------------------|
| + sehr gute Hitzebeständigkeit | - teurer als Thermoplast |
| + sehr gute Schlagfestigkeit | - schwierige Bearbeitung |
| + gute Korrosionsbeständigkeit | - nicht „recyclingfähig“ |
| + gute Chemikalienbeständigkeit | |
| + eignet sich für sehr anspruchsvolle industrielle Anwendungsbereiche | |
| + UV-Beständigkeit | |
| + Halogenfrei | |

| Säurebeständiger Stahl (AISI 316) | |
|--|---|
| Wie AISI 304, darüber hinaus: | - teurer als rostfreier Stahl |
| + besonders hohe Korrosionsbeständigkeit | - Bearbeitung schwieriger als bei lackiertem Stahlblech |
| + ideal in der Off-Shore Industrie | |
| + ausgezeichnet geeignet für die Papierindustrie | |

Material

| Polycarbonate (PC) | |
|--|---|
| + high impact resistance | - because of the fibreglass used, achieving the correct color shade maybe difficult |
| + high degree of protection | |
| + light weight | |
| + good resistance to chemicals | |
| + wide temperature range | |
| + self-extinguishing | |
| + easily machined using standard tools | |
| + excellent insulation properties | |
| + also suitable for outdoor use | |
| + UV radiation resistance | |
| + Halogen free | |

| Polystyrene-Painted mild Steel | |
|--|------------------|
| + high impact resistance | - corrosion risk |
| + high degree of protection | |
| + easy to customize; special dimensions possible | |

| Stainless Steel (AISI 304) | |
|--|--|
| + high impact resistance | - more expensive than painted mild steel |
| + high degree of protection | - customizing more difficult than with painted steel |
| + excellent corrosion resistance | |
| + excellent resistance to UV radiation | |
| + suitable for industrial environments | |
| + excellent suitability for e.g. the food industry | |

| Polyester (GRP, glass-reinforced-polyester) | |
|--|---|
| + excellent temperature resistance | - more expensive than thermoplastic materials |
| + excellent impact resistance | - machining problematic |
| + good corrosion resistance | - non-recyclable material |
| + good resistance against solvents | |
| + suitability for highly demanding industrial environments | |
| + UV radiation resistance | |
| + Halogen free | |

| Acid-Proof Steel (AISI 316) | |
|--|--|
| As AISI 304, also: | - more expensive than stainless steel |
| + extremely high resistance to corrosion | - customizing more difficult than with painted steel |
| + excellent suitability for off-shore industry | |
| + excellent suitability for paper industry | |



HUGRO®
Qualität aus Waldkirch

HUGRO-Armaturen GmbH
Rudolf-Blessing-Straße 5
79183 Waldkirch / Germany

Tel. +49 (0) 76 81 / 4073-0
Fax +49 (0) 76 81 / 4073-40
E-Mail info@hugro.com

www.hugro.com



Unsere Allgemeinen Verkaufs- und Lieferbedingungen finden Sie unter: www.hugro.com/impresum

Spezialist für Kabelverschraubungen, Kabelschutz,
Zubehör, Serien- und Sondergehäuse

www.hugro.com

HUGRO 0322